

Music Line

SKOFF

Music Line short

Najlepsza inwestycja w światło

The best investment in light

Die beste Investition ins Licht

Najlepší investice v světlo



SKOFF DESIGN



Dziękujemy

Thank you

Vielen Dank

Děkuji

Spis treści



Table of Contents • Inhaltsverzeichnis • Obsah

Objaśnienia • Explanatory notes • Erklärungen • Vysvětlení	4
Montaż • Assembly • Montage • Montáž	5
TANGO	8
TANGO MINI	8
TANGO MAX	8
TANGO short	9
TANGO MINI short	9
TANGO MAX short	9
DUO TANGO	10
DUO TANGO short	10
Kinkiet • Wall light • Wandleuchte • Šikovnost DUO TANGO	10
RUEDA	12
RUEDA MINI	12
RUEDA short	13
RUEDA MINI short	13
RUMBA	13
DUO RUEDA	14
DUO RUEDA short	14
Kinkiet • Wall light • Wandleuchte • Šikovnost DUO RUEDA	14
SALSA	16
SALSA MINI	16
SALSA MAX	16
SALSA short	17
SALSA MINI short	17
SALSA MAX short	17
DUO SALSA	18
DUO SALSA short	18
BOLERO OL7	19
Zasilacze napięciowe • CV Power supplies • Netzteile • Napájecí zdroje	20
ZOL 6	20
ZOL 16	20
ZOL 19-10	20
ZOL 7-10	21
ZOL15-10	21
PUSZKA ELEKTROINSTALACYJNA P50 • Junction box P50 • Einbaudose P50 • Instalační krabice P50	21
PUSZKA ELEKTROINSTALACYJNA P60 • Junction box P60 • Einbaudose P60 • Instalační krabice P60	21
Materiały reklamowe • Advertising materials • Werbematerial • Reklamní materiály	22
MINI STAND MUSIC LINE / MUSIC LINE short / BOLERO	22
TABLICA REKLAMOWA 1 ML • Advertising board 1 ML • Werbetafel 1 ML • Reklamní tabule ML1	23
INDEKS • INDEX	24

Rodzaj powierzchni • Surface finish • Oberfläche • Druh povrchu:

	G Aluminium Aluminium Hliník		K Stal szlachetna (INOX) Stainless steel (INOX) Edelstahl (INOX) Ušlechtilá ocel (INOX)		M Mosiądz mat Matte brass Messing matt Matná mosaz
	D Czarny Black Schwarz Černá		I Nikiel Szlif Brushed nickel Nickel geschliffen Nikl brus		C Biały White Weiß Bílá

Kolor emisji światła • Colour of light • Lichtfarbe • Barva emise světla:

	W zimny biały • cool white • Kaltweiß • studená bílá
	WW ciepły biały • warm white • Warmweiß • teplá bílá
	B niebieski • blue • Blau • modrá

0,8 W Moc • Power • Leistung • Výkon	10 V DC Napięcie znamionowe • Rated voltage • Nennspannung • Jmenovitě napětí	Ra >80 Współczynnik oddawania barw Ra (CRI) • Colour rendering index • Farbwiedergabeindex • Index podání barev	6000 K Temperatura barwowa [K] • Color temperature [K] • Farbtemperatur [K] • Barevná teplota [K]
 Do montażu na powierzchniach normalnie palnych • Suitable for installation on normally flammable surfaces • Zur Montage auf normal entflamm-baren Flächen • K montáži na normálně hořlavé povrchy	 II Klasa ochronności • II Protection class • II Schutzklasse • II Třída ochrannosti	 III Klasa ochronności • III Protection class • III Schutzklasse • III Třída ochrannosti	 Źródło światła LED • LED light source • LED-Lichtquelle • Zdroj světla LED
IP20 Ochrona przed wnikaniem ciał obcych. Brak ochrony przed szkodliwym wnikaniem wody • Protection against ingress of foreign bodies. Not protected from harmful water ingress • Geschützt gegen feste Fremdkörper. Kein Schutz gegen Beschädigung durch Wasser • Chráněno proti proniknutí cizích pevných těles. Není chráněno proti škodlivému průniku vody	IP44 Ochrona przed bryzgami wody • Protection against water spray • Schutz gegen allseitiges Spritzwasser • Chráněno proti stříkající vodě	 Ochrona przed wnikaniem pyłu oraz silnymi strugami wody • Protection against total dust ingress and strong water jets • Staubdicht und gegen starkes Strahlwasser geschützt • Chráněno proti prachu a proti stříkající vodě	 Pełna ochrona przed wnikaniem pyłów i ciał stałych oraz głębokim zanurzeniem w wodzie • Total protection against solid objects, dust ingress and deep immersion in water • Gegen Staub und feste Fremdkörper und gegen dauerndes Untertauchen geschützt • Plně chráněno proti proniknutí prachu, cizích pevných těles a proti ponoření do vody



Zgodność z dyrektywami Unii Europejskiej • Compliance with EU Directives • In Übereinstimmung mit den Verordnungen der EU • Shodnost s příslušnými směrniciemi Evropské unie

STANDARD,
DUO

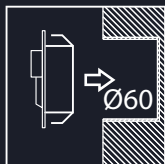

STICK



MINI

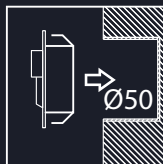

KINKIET
WALL LIGHT

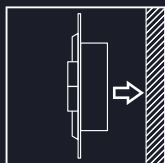

MAX

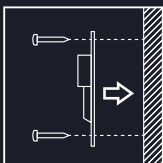

MUSIC LINE

MUSIC LINE short

TANGO, RUEDA, SALSA,
RUMBA, BOLERO

MADE IN POLAND



Odporne na silne strugi wody.
Resistant to strong water jets.
Beständig gegen Schlagregen.
Odloné proti silnému proudu vody.



Oprawa przeznaczona do montażu wewnątrz i na zewnątrz budynku.

A luminaire for indoor and outdoor installation.

Die Leuchte ist für den Innen- und Außenbereich geeignet.

Svítlidlo určené k montáži v interiéru a venku.

MUSIC LINE

Odnaczona Złotym Medalem Targów Poznańskich linia oświetleniowa MUSIC LINE podświetli ciągi komunikacyjne, schody i witryny meblowe. Charakter wnętrza doskonale podkreślą rodziny produktów: TANGO, RUEDA, SALSA, RUMBA i BOLERO. Bardzo płaskie obudowy opraw (10,5 mm) wykonane są ze stali szlachetnej lub z aluminium. Oświetlenie wykorzystuje energooszczędną technologię LED, co minimalizuje koszty użytkowania. Oprawy nie nagrzewają się nawet przy długotrwałym świeceniu.

A HERMETIC family line of luminaires – MUSIC LINE, winner of the Gold Medal at the Poznan International Fair, can be used for illuminating traffic routes, paths or stairs, not only indoors but also outdoors. The atmosphere of your venue will be perfectly highlighted by four product families: TANGO, RUEDA, SALSA, RUMBA, and BOLERO. The ultra-flat fixtures of these luminaires (10.5 mm) are made of stainless steel or aluminum. The lighting system uses energy-saving LED technology, minimizing the operating costs. The luminaires will not get hot, even if they are on for a long time.

Die mit der goldenen Medaille der Internationalen Messe in Poznań ausgezeichnete Leuchtenreihe MUSIC LINE von der Serie HERMETIC beleuchtet die Verkehrsstränge, Gehwege und Treppen nicht nur in den Innenräumen, sondern auch im Außenbereich. Die Raumatmosphäre wird mit den vier Produktfamilien einmalig hervorgehoben: RUEDA, RUMBA, SALSA und TANGO. Sehr flache Leuchten (10,5 mm) werden aus Edelstahl oder aus Aluminium gefertigt. Dank der energiesparenden LED-Technologie werden die Betriebskosten minimiert. Die Leuchten werden auch bei Dauerbetrieb nicht warm.

Oceněná zlatou medaili na Poznaňských veletrzích linie svítidel MUSIC LINE osvětlí chodby, schody a nábytková skla. Charakter každého interiéru skvěle zdůrazní skupiny výrobků: TANGO, RUEDA, RUMBA, SALSA a BOLERO. Velmi ploché kryty svítidel (10,5 mm) jsou vyrobeny z ušlechtilé oceli nebo hliníku. Svítidla využívají úspornou technologii LED, což snižuje provozní náklady. Svítidla se nezahřívají ani při dlouhodobém svícení.

MUSIC LINE short

Nowoczesna i ergonomiczna linia oświetleniowa MUSIC LINE SHORT nada ton każdemu pomieszczeniu, oświetlając schody, ciągi komunikacyjne, witryny meblowe, czy podkreślając aranżację wnętrza. MUSIC LINE SHORT to przede wszystkim delikatniejsze światło, uzyskane dzięki oświetleniu kurtynowemu, subtelnie podkreślające architektoniczne detale. Technologia LED zminimalizuje koszty energii nawet przy długotrwałym użytkowaniu. Trwałe i bezpieczne obudowy MUSIC LINE SHORT wykonane są ze stali szlachetnej lub aluminium. Nie nagrzewają się nawet przy długotrwałym działaniu.

MUSIC LINE SHORT, a modern and ergonomic line of luminaires, will give unique character to any venue - it will illuminate stairs, traffic routes, cabinet fronts, or emphasizing the interior arrangement. MUSIC LINE SHORT mainly means more delicate light, achieved through curtain lighting, and subtly emphasizing the architectural details. LED technology will minimize the costs of energy, even for long-term use. Durable and safe MUSIC LINE SHORT luminaires are made of stainless steel or aluminum. They will not get hot, even if they are on for a long time.

Die moderne und ergonomische Leuchtenreihe MUSIC LINE SHORT verleiht jedem Raum die entsprechende Atmosphäre, indem sie die Treppen, Verkehrsstränge und Vitrinen beleuchtet und die Raumgestaltung betont. MUSIC LINE SHORT bedeutet vor allem ein sanftes Licht, das eine Art Lichtvorhang bildet und die architektonischen Details fein akzentuiert. Die LED-Technologie minimiert die Energiekosten auch bei Dauerbetrieb. Stabile und sichere Leuchten MUSIC LINE SHORT werden aus Edelstahl oder aus Aluminium gefertigt. Sie werden auch bei Dauerbetrieb nicht warm.

Moderní a ergonomická linie svítidel MUSIC LINE SHORT vyplní světlem každý interiér: Zajistí osvětlení chodby, schodiště a nábytkového skla při kterém zdůrazní vybavení interiéru. MUSIC LINE SHORT znamená především jemnější světlo, získané díky efektovi světelné opony, který subtilním způsobem zdůrazní architektonické detaily. Technologie LED minimalizuje náklady na energii, dokonce při dlouhodobém svícení. Pevná a bezpečná svítidla MUSIC LINE SHORT jsou vyrobená z ušlechtilé oceli a hliníku. Nezahřívají se ani při dlouhodobém svícení.

UWAGA!

Oprawy zasilane niskim napięciem 10 V DC.

Caution! Fittings powered by low-voltage 10 V DC!

Achtung! Die Leuchten werden mit Niederspannungsstrom 10 V DC versorgt!

Svítlidla napájené nízkým napětím 10 V DC.

Firma lokalna o zasięgu globalnym

SKOFF jest polskim producentem wyrobów oświetleniowych i osprzętu elektrotechnicznego. Swoją działalność skupia na dostarczaniu rozwiązań zarówno dla profesjonalistów, jak i zwykłych konsumentów.

A local business with a global reach

SKOFF is a Polish manufacturer of lighting products and electro-technical equipment. The company focuses on delivering solutions for professionals as well as ordinary consumers.

Eine lokale Firma mit globaler Reichweite

SKOFF ist ein polnischer Hersteller von Beleuchtung und Elektrotechnik-Zubehör. Der Schwerpunkt der Firma liegt in der Bereitstellung von Lösungen sowohl für Profis, als auch für Privatkunden.

Lokální firma s globálním dosahem

SKOFF je polský výrobce svítidel a elektrotechnického vybavení. Ve svém působení se soustředí na poskytování řešení jak pro profesionály, tak i pro běžné klienty.

SKOFF

ul. Legionów 243 D
43-500 Czechowice-Dziedzice
POLAND

www.skoff.pl



Seria TANGO

TANGO (G, K, D, C) • stick (G, D, C)

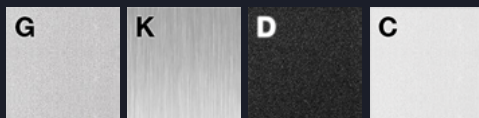
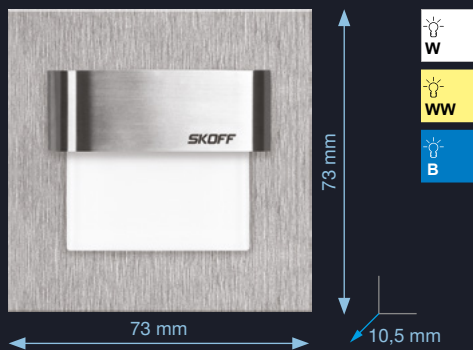

0,8 W	6000 K 3000 K	10 V DC	IP20	IP66
Ra > 80	33 lm 32 lm	LED	III	CE

TANGO MINI (G, K, D, C) • stick (G, D, C)

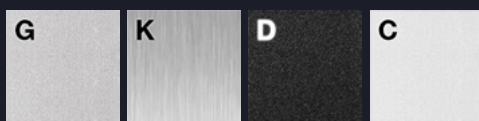
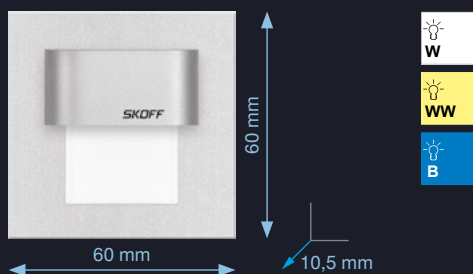

0,4 W	6000 K 3000 K	10 V DC	IP20	IP66
Ra > 80	15 lm 15 lm	LED	III	CE

TANGO MAX (G)

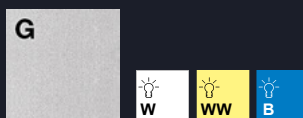

1,6 W	6000 K 3000 K	10 V DC	IP20	IP66
Ra > 80	64 lm 62 lm	LED	III	CE

TANGO short (G, K, D, C) • stick (G, D, C)

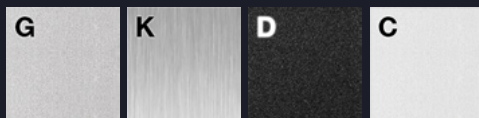
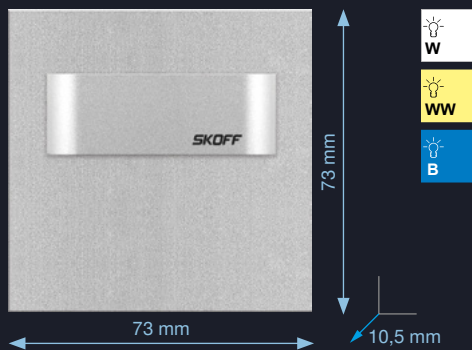

0,8 W	6000 K 3000 K	10 V DC	IP20	ΔIP66
Ra > 80	22 lm 21 lm	LED	III	CE

TANGO MINI short (G, K, D, C) • stick (G, D, C)

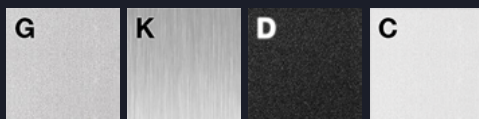
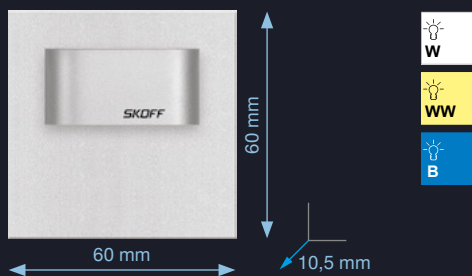

0,4 W	6000 K 3000 K	10 V DC	IP20	ΔIP66
Ra > 80	17 lm 16 lm	LED	III	CE

TANGO MAX short (G)

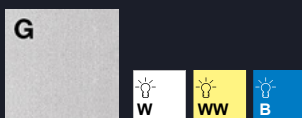

1,6 W	6000 K 3000 K	10 V DC	IP20	ΔIP66
Ra > 80	61 lm 61 lm	LED	III	CE

Seria TANGO

DUO TANGO (G, K)

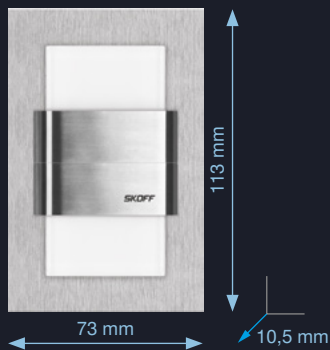

1,6 W	6000 K 3000 K	10 V DC	IP20	ΔIP66
Ra > 80	66 lm 64 lm	LED	III	CE

DUO TANGO short (G, K)

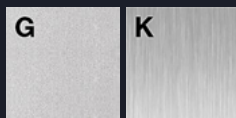
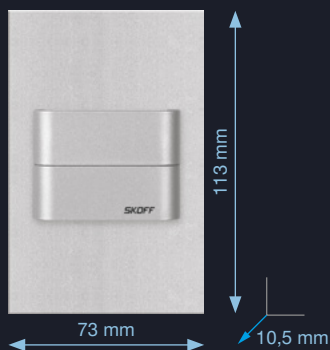

1,6 W	6000 K 3000 K	10 V DC	IP20	ΔIP66
Ra > 80	43 lm 41 lm	LED	III	CE

Kinkiet • Wall light • Wandleuchte • Šikovnost DUO TANGO (G, K)

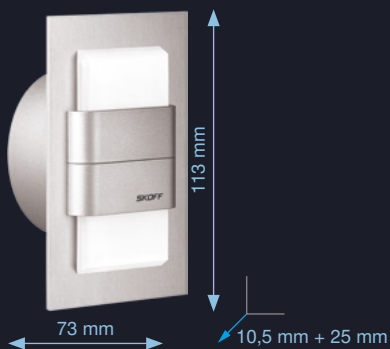

1,6 W	6000 K 3000 K	10 V DC	IP20	ΔIP66
Ra > 80	66 lm 64 lm	LED	III	CE



Seria RUEDA

RUEDA (G, K, D, C) • stick (G, D, C)

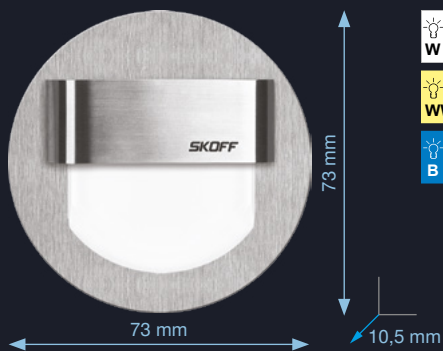

0,8 W	6000 K 3000 K	10 V DC	IP20	ΔIP66
Ra > 80	32 lm 28 lm	LED	III	CE

RUEDA MINI (G, K, D, C) • stick (G, G, D, C)

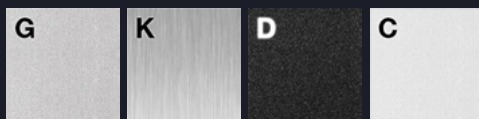
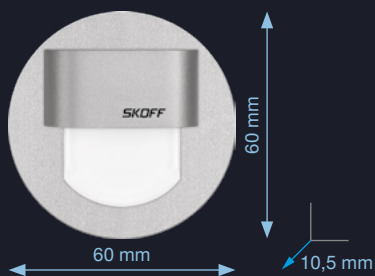

0,4 W	6000 K 3000 K	10 V DC	IP20	ΔIP66
Ra > 80	13 lm 12 lm	LED	III	CE



RUEDA short (G, K, D, C) • stick (G, D, C)

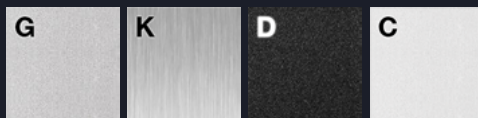
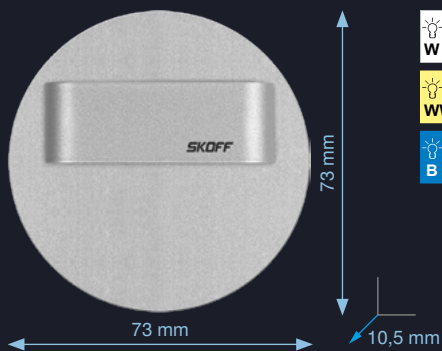

0,8 W	6000 K 3000 K	10 V DC	IP20	IP66
Ra > 80	22 lm 21 lm	LED	III	CE

RUEDA MINI short (G, K, D, C) • stick (G, D, C)

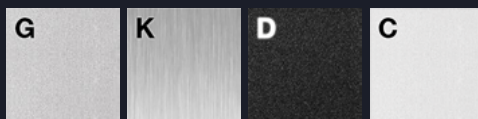
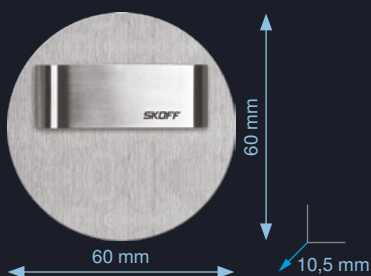

0,4 W	6000 K 3000 K	10 V DC	IP20	IP66
Ra > 80	16 lm 17 lm	LED	III	CE

Seria RUMBA

RUMBA stick (G)

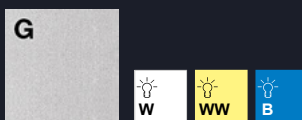

0,8 W	6000 K 3000 K	10 V DC	IP20	IP66
Ra > 80	28 lm 27 lm	LED	III	CE

Seria RUEDA

DUO RUEDA (G, K)

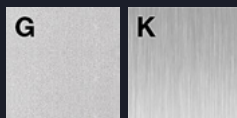
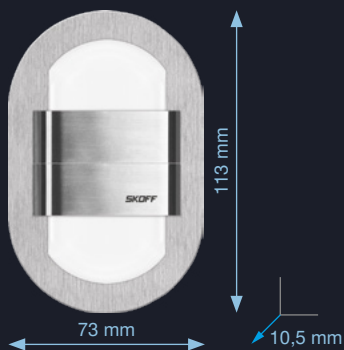

1,6 W	6000 K 3000 K	10 V DC	IP20	IP66
Ra > 80	64 lm 56 lm	LED	III	CE

DUO RUEDA short (G, K)

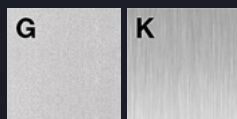
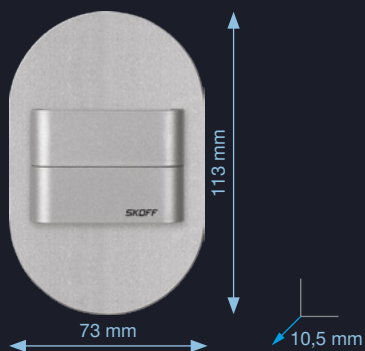

1,6 W	6000 K 3000 K	10 V DC	IP20	IP66
Ra > 80	43 lm 41 lm	LED	III	CE

Kinkiet • Wall light • Wandleuchte • Šikovnost DUO RUEDA (G, K)

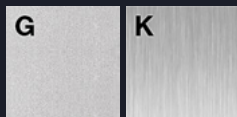
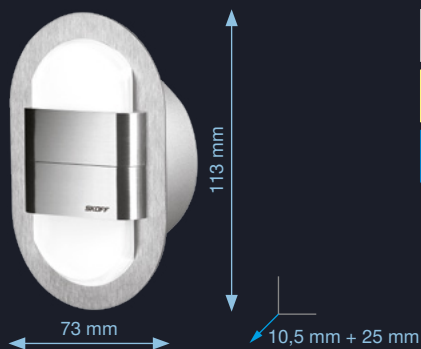

1,6 W	6000 K 3000 K	10 V DC	IP20	IP66
Ra > 80	64 lm 56 lm	LED	III	CE



Seria SALSA

SALSA (M)

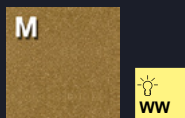
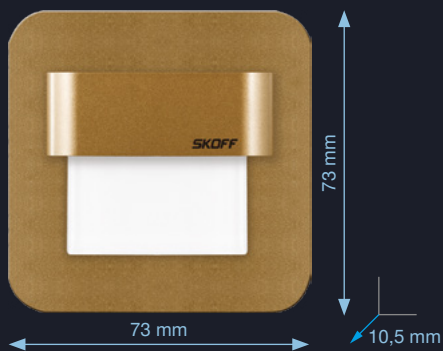

0,8 W	3000 K	10 V DC	IP20	
Ra > 80	32 lm			

SALSA MINI (M)

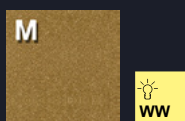
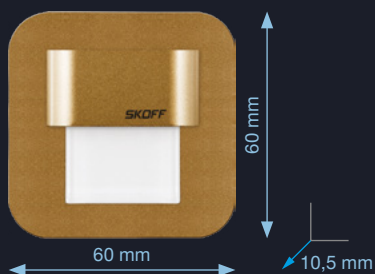

0,4 W	3000 K	10 V DC	IP20	
Ra > 80	15 lm			

SALSA MAX (M)

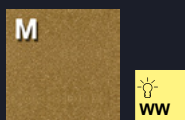

1,6 W	3000 K	10 V DC	IP20	
Ra > 80	62 lm			

SALSA short (M)

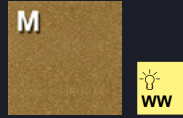
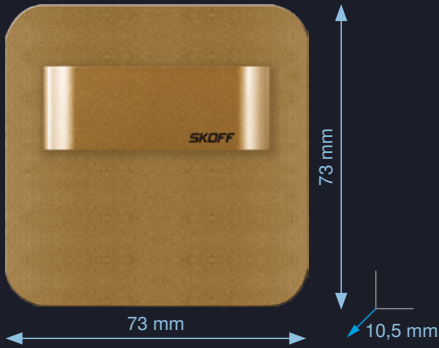

0,8 W	3000 K	10 V DC	IP20	
Ra > 80	21 lm	LED		

SALSA MINI short (M)

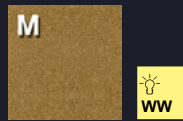
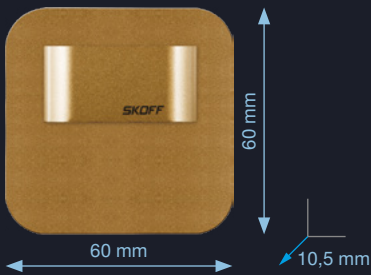

0,4 W	3000 K	10 V DC	IP20	
Ra > 80	17 lm	LED		

SALSA MAX short (M)

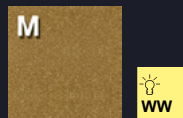

1,6 W	3000 K	10 V DC	IP20	
Ra > 80	61 lm	LED		

Seria SALSa

DUO SALSa (M)

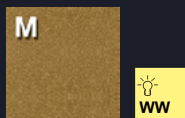
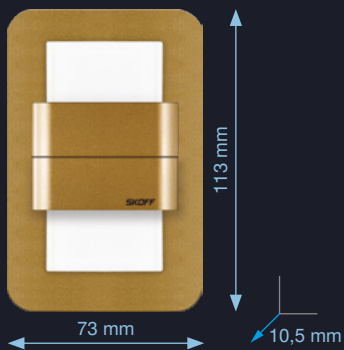

1,6 W	3000 K	10 V DC	IP20	ΔIP66
Ra > 80	64 lm	LED	III	CE

DUO SALSa short (M)

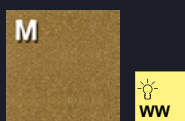
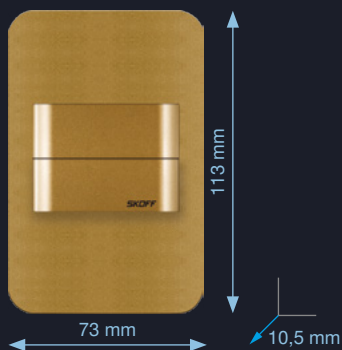

1,6 W	3000 K	10 V DC	IP20	ΔIP66
Ra > 80	41 lm	LED	III	CE

Różnice w świeceniu
Lighting differences
Lichtunterschiede
Rozdíly v svícení

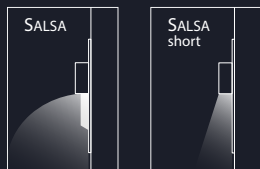

Oprawy short zapewniają świecenie kurtynowe.

Short luminaires give curtain lighting.

Die Beleuchtung mit den Short-Leuchten bildet eine Art Lichtvorhang.



Svitidla short tvoří efekt světlé opony.

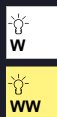

Seria BOLERO

BOLERO OL7 (G, I, D)



1,8 W	6000 K 3000 K	10 – 12 V DC	IP20
Ra > 80	54 lm 49 lm	LED	 



Zasilacze napięciowe • CV Power supplies • Netzteile

• Napájecí zdroje

Innowacyjne zasilacze impulsowe marki SKOFF służą do zasilania napięciem stałym (10 V DC) obwodów i urządzeń elektronicznych (elektrycznych). Charakteryzują się małymi gabarytami i niewielką wagą. Niektóre z nich swym kształtem pasują do tradycyjnych puszek elektro-instalacyjnych. Idealnie nadają się do zasilania opraw serii Music Line.

SKOFF's innovative pulsed power supplies provide direct current voltage (10 V DC) to other circuits and electronic (electric) devices. They are compact-sized and lightweight. Some will fit into traditional electrical junction boxes. Ideal for supplying power to the Music Line luminaires.

Innovative Schaltnetzteile von SKOFF versorgen mit Gleichspannung (10 V DC) sonstige elektronische (elektrische) Schaltungen und Geräte. Sie sind klein und leicht. Einige Formen passen auch in die üblichen Elektroinstallationsdosen. Sie eignen sich ideal zur Versorgung der Music Line-Leuchten.

Inovační impulzní napájecí zdroje značky SKOFF slouží k napájení stejnosměrného proudu (10 V DC) ostatního elektrického vedení a elektronických zařízení či spotřebičů. Vyznačuje se malou hmotností a velikostí. Některé tvárově odpovídají tradičním elektroinstalačním krabicím. Ideálně se hodí k napájení svítidel sérií Music Line.

ZOL 6



93 x 35 x 22 mm

6 W	10 V DC	0,6 A	50 Hz	230 V AC

ZOL 16



90 x 43 x 29 mm

16 W	10 V DC	1,6 A	50 Hz	230 V AC

ZOL 19-10



90 x 43 x 29 mm

19 W	10 V DC	1,9 A	50 Hz	230 V AC

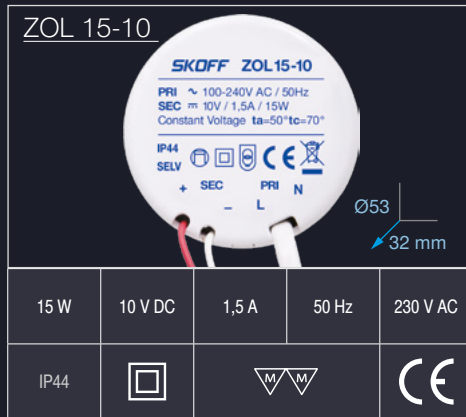
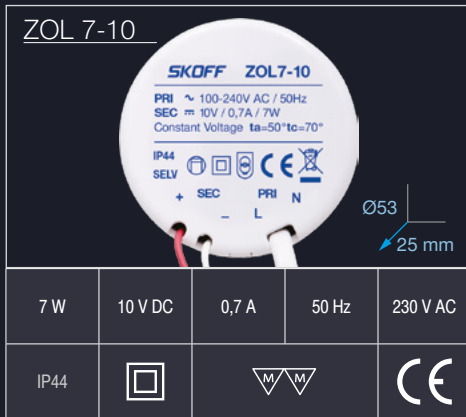

Przykładowy schemat podłączenia elektrycznego • LED circuit example • Beispiel für einen Elektroanschluss • Příklady instalačních schémat:

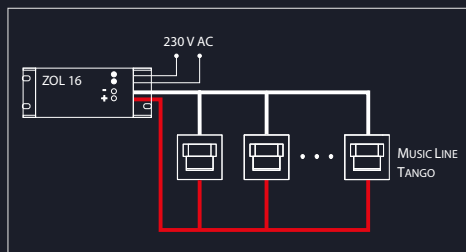
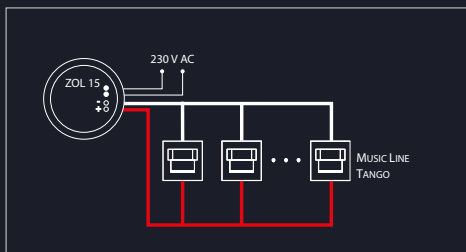

UWAGA • CAUTION • ACHTUNG • POZOR

Łączna moc zastosowanych opraw ML nie może przekraczać mocy znamionowej transformatora zasilającego • The total power of installed ML luminaires may not exceed the power rating of the power supply transformer • Die gesamte Leistung der eingesetzten ML-Leuchten darf die Nennleistung des Transformators nicht übersteigen • Celkový výkon použitých svítidel ML nesmí přesáhnout jmenovitý výkon napájecího transformátoru.

PUSZKA ELEKTROINSTALACYJNA P50

Junction box P50 • Einbaudose P50 • Instalační krabice P50



PUSZKA ELEKTROINSTALACYJNA P60

Junction box P60 • Einbaudose P60 • Instalační krabice P60



MINI STAND MUSIC LINE / MUSIC LINE short / BOLERO



SKOFF

Oświetlenie ściienne

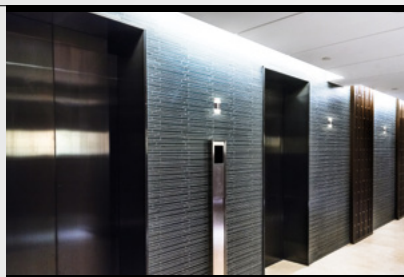

Oświetlenie schodowe

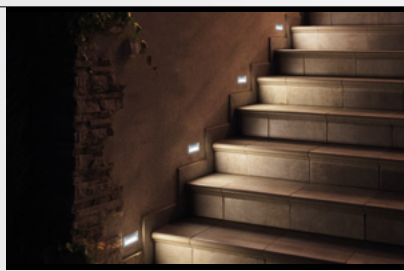

SKOFF DESIGN

Made in Poland • www.skoff.pl

850 mm

1000 mm

INDEKS • INDEX

Każdy produkt marki SKOFF posiada swój indywidualny indeks • Each SKOFF product has its own unique index. An example of how indexes are formed, based on a product from the ML range, is presented below • Jedes Produkt von SKOFF hat seinen eigenen Index. Nachstehend wird der Index-Aufbau am Beispiel einer ML-Leuchte dargestellt • Každý výrobek značky SKOFF má svůj individuální Index.



Przykład indeksu dla oprawy Tango / wykonanie: szlif / kolor świecenia: niebieski • Example of a Tango luminaire index/finish: steel / lighting colour: blue • Index-Beispiel für die Leuchte Tango/ Oberfläche: Edelstahl / Lichtfarbe: blau • Příklad indexu pro svítidlo Tango a jeho provedení: zábrus / barva svícení: modrá.

ML-TAN-K-B

WYKOŃCZENIE • FINISHING • VERARBEITUNGSART • FINIŠ:

K Szlif • Stainless steel (INOX) • Edelstahl (INOX) • INOX
G Aluminium • Aluminium • Aluminium • Hliník
D Czarny • Black • Schwarz • Černá
C Biały • White • Weiß • Bílá • Mosiądz mat • Matte brass • Messing
M mat • Matná mosaz'

BARWA ŚWIATŁA • COLOUR OF LIGHT • LICHTFARBE • BARVA SVĚTLA:

W Zimny biały • Cool white • Kaltweiß • Studená bílá
H Ciepły biały • Warm white • Warmweiß • Teplá bílá
B Niebieski • Blue • Blau • Modrá

GRUPA • GROUP • GROUP • SKUPINA	NAZWA • NAME • NAMEN • NAZEV	WYKOŃCZENIE • FINISHING • VERARBEITUNGSART • FINIŠ	BARWA ŚWIATŁA • COLOUR OF LIGHT • LICHTFARBE • BARVA SVĚTLA
ML MUSIC LINE IP20	TAN Tango	K	W
	TMI Tango mini	G	H
	RUE Rueda	D	B
	RMI Rueda mini	C	
	TST Tango stick	G	W
	TMS Tango mini stick	D	H
	RST Rueda stick	C	B
	RMS Rueda mini stick		
	TDU Duo Tango		W
	TDK Kinkiet Duo Tango	K	H
	RDU Duo Rueda	G	B
	RDK Kinkiet Duo Rueda		
	SAL Salsa		
	SMI Salsa mini		
	SST Salsa stick		H
	SMS Salsa mini stick	M	
	SMX Salsa Max		
	SDU Duo Salsa		
MH MUSIC LINE HERMETIC IP66	TMX Tango Max	G	W
	RUM Rumba		H
			B
	TAN Tango	K	W
	TMI Tango mini	G	H
	RUE Rueda	D	B
	RMI Rueda mini	C	
	TST Tango stick	G	W
	TMS Tango mini stick	D	H
	RST Rueda stick	C	B
	RMS Rueda mini stick		
	TDU Duo Tango		W
	TDK Kinkiet Duo Tango	K	H
	RDU Duo Rueda	G	B
	RDK Kinkiet Duo Rueda		
	SAL Salsa		
	SMI Salsa mini		
	SST Salsa stick		H
SMS Salsa mini stick	M		
SMX Salsa Max			
SDU Duo Salsa			

MI MUSIC LINE SHORT IP20	TMX Tango Max	G	W
	RUM Rumba		H
			B
	TAN Tango Short	K	W
	TMI Tango Mini Short	G	H
	RUE Rueda Short	D	B
	RMI Rueda Mini Short	C	
	TST Tango Stick Short	G	W
	TMS Tango Mini Stick Short	D	H
	RST Rueda Stick Short	C	B
	RMS Rueda Mini Stick Short		
	TDU Duo Tango Short	K	W
	RDU Duo Rueda Short	G	H
			B
	SAL Salsa Short		
SMI Salsa Mini Short			
SST Salsa Stick Short			
SMS Salsa Mini Stick Short	M	H	
SMX Salsa Max Short			
SDU Duo Salsa Short			
TMX Tango Max Short	G	W	
		H	
		B	

MS MUSIC LINE SHORT HERMETIC IP66	TAN Tango Short	K	W
	TMI Tango Mini Short	G	H
	RUE Rueda Short	D	B
	RMI Rueda Mini Short	C	
	TST Tango Stick Short	G	W
	TMS Tango Mini Stick Short	D	H
	RST Rueda Stick Short	C	B
	RMS Rueda Mini Stick Short		
	TDU Duo Tango Short	K	W
	RDU Duo Rueda Short	G	H
			B
	SAL Salsa Short		
	SMI Salsa Mini Short		W
	SST Salsa Stick Short		H
	SMS Salsa Mini Stick Short	M	B
SMX Salsa Max Short			
SDU Duo Salsa Short			
TMX Tango Max Short	G	W	
		H	
		B	

OL Oprawy LED • LEDFittings • LED-Leuchten • LED Svítidla	OL7 Bolero	I	W
		G	H
		D	

GRUPA • GROUP • GROUP • SKUPINA	NAZWA • NAME • NAMEN • NÁZEV	NAPIĘCIE • VOLTAGE • STROMSPANNUNG • NAPĚTÍ	TYP • TYPE • TYP • TYP
ZL Zasilacze LED LED Power Supply LED Netzteile Napáječe LED	006 ZOL6		
	007 ZOL7-10		
	015 ZOL15-10	C 10 V DC	1
	016 ZOL16		
	019 ZOL19-10		

GRUPA • GROUP • GROUP • SKUPINA	NAZWA • NAME • NAMEN • NÁZEV	TYP • TYPE • TYP • TYP	KOLOR • COLOUR • FARBE • BARVA
AO Akcesoria oświetleniowe • Lighting accessories • Einbaudose • Příslušenství k osvětlení	PEI Puszka elektroinstalacyjna • Junction box • Einbaudose • Instalační krabice	5 P50	G Szary • Grey • Grau • Šedá
		6 P60	B Czarny • Black • Schwarz • Černá

Dystrybutor • Distributor

SKOFF

43-500 Czechowice-Dziedzice
ul. Legionów 243 D
POLAND
tel./fax +48 (32) 215 28 93
email: info@skoff.pl

www.skoff.pl

SKOFF DESIGN