

NEONY LED

TAŚMY COB

 **nextec**

NEON LED FLEX 6x12

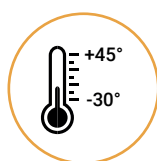
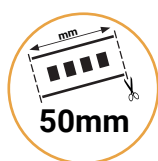
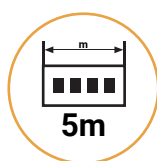
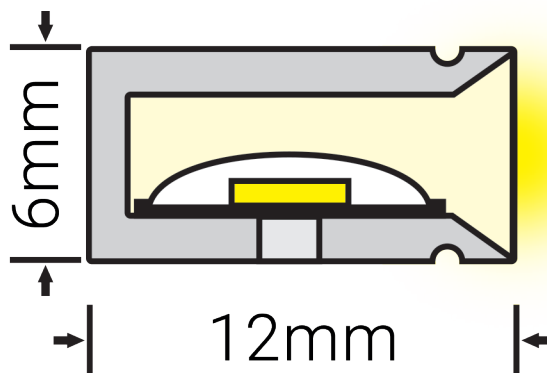

Nr. katalogowy/Catalog number	PJ033140	PJ026951	PJ026968	PJ029037	PJ029044	PJ030118
Kod EAN/BARCODE	5908293933140	5908293926951	5908293926968	5908293929037	5908293929044	5908293930118
Dioda/Led	2835	2835	2835	2835	2835	3838
Ilość diod na m/LED per meter	120xLED/m	120xLED/m	120xLED/m	120xLED/m	120xLED/m	96xLED/m
Moc/Power	9,6W/m	9,6W/m	9,6W/m	9,6W/m	9,6W/m	9,6W/m
Napięcie zasilające/Voltage	24V DC	24V DC	24V DC	24V DC	24V DC	24V DC
Temperatura barwy/Colour temp.	3000K (+/-200K)	4000K (+/-200K)	6500K (+/-300K)	620-623 nm 920 mcd	460-465 nm 900 mcd	R:620-625 nm R:500-700 mcd G:520-525 nm G:1300-1800 mcd B:465-470 nm B:400-600 mcd
Strumień świetlny/Lumens	430lm/m	480lm/m	480lm/m			
Żywotność/Life Expectancy	30000h	30000h	30000h	30000h	30000h	30000h
Kąt świecenia/Lighting angle	120°	120°	120°	120°	120°	120°

AKCESORIA



PJ027873
Silikonowa końcówka
(POCZĄTEK)



PJ027866
Silikonowa końcówka
(KONIEC)



PJ033157
Łącznik przezroczysty
środkowy



PJ033164
Łącznik przezroczysty
z przewodem



PJ027859
Aluminiowy
klips do montażu



PJ027842
Profil aluminiowy
anodowany



NEON LED FLEX 10x10R

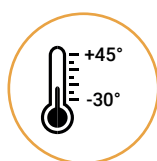
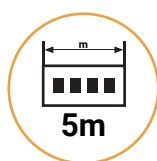
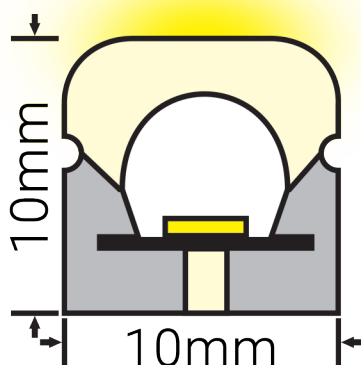

Nr. katalogowy/Catalog number	PJ033171	PJ033188	PJ033195	PJ033201	PJ033218	PJ033287
Kod EAN/BARCODE	5908293933171	5908293933188	5908293933195	5908293933201	5908293933218	5908293933287
Dioda/Led	2835	2835	2835	2835	2835	3838
Ilość diod na m/LED per meter	120xLED/m	120xLED/m	120xLED/m	120xLED/m	120xLED/m	96xLED/m
Moc/Power	14,4W/m	14,4W/m	14,4W/m	14,4W/m	14,4W/m	14,4W/m
Napięcie zasilające/Voltage	24V DC	24V DC	24V DC	24V DC	24V DC	24V DC
Temperatura barwy/Colour temp.	3000K (+/-200K)	4000K (+/-200K)	6500K (+/-300K)	80-1000mcd	1000-1200mcd	RGB 2000-2500mcd
Strumień świetlny/Lumens	700lm/m	750lm/m	750lm/m			
Żywotność/Life Expectancy	30000h	30000h	30000h	30000h	30000h	30000h
Kąt świecenia/Lighting angle	120°	120°	120°	120°	120°	120°

AKCESORIA



PJ033225
Silikonowa końcówka
(POCZĄTEK)



PJ033232
Silikonowa końcówka
(KONIEC)



PJ033263
Łącznik przezroczysty
środkowy



PJ033270
Łącznik przezroczysty
z przewodem

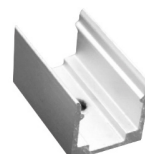

PJ033249
Aluminiowy
klips do montażu



PJ033263
Profil aluminiowy
anodowany

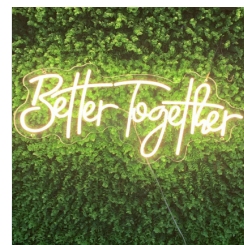
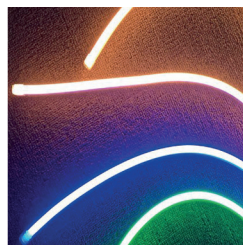
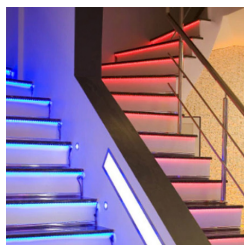

NEON LED FLEX 10x22

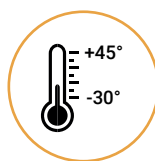
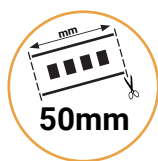
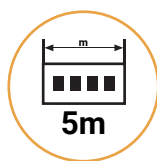
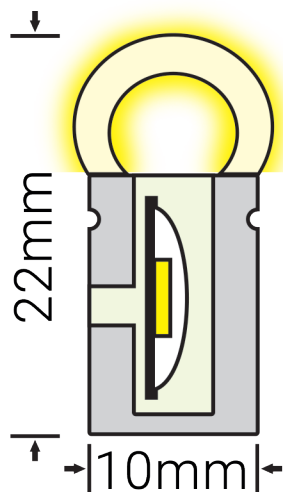

Nr. katalogowy/Catalog number	PJ033294	PJ033300	PJ033317	PJ033324	PJ033331	PJ033409
Kod EAN/BARCODE	5908293933294	5908293933300	5908293933317	5908293933324	5908293933331	5908293933409
Dioda/Led	2835	2835	2835	2835	2835	2835
Ilość diod na m/LED per meter	120xLED/m	120xLED/m	120xLED/m	120xLED/m	120xLED/m	120xLED/m
Moc/Power	18W/m	18W/m	18W/m	18W/m	18W/m	18W/m
Napięcie zasilające/Voltage	24V DC	24V DC	24V DC	24V DC	24V DC	24V DC
Temperatura barwy/Colour temp.	3000K (+/-200K)	4000K (+/-200K)	6500K (+/-300K)	800-1000mcd	1000-1200mcd	RGB 2000-2500mcd + 4000K
Strumień świetlny/Lumens	720lm/m	760lm/m	780lm/m			
Żywotność/Life Expectancy	30000h	30000h	30000h	30000h	30000h	30000h
Kąt świecenia/Lighting angle	120°	120°	120°	120°	120°	120°

AKCESORIA



PJ033348
Silikonowa końcówka
(POCZĄTEK)



PJ033355
Silikonowa końcówka
(KONIEC)



PJ033386
Łącznik przezroczysty
środkowy



PJ033393
Łącznik przezroczysty
z przewodem



PJ033362
Aluminiowy
klips do montażu

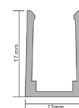

PJ033379
Profil aluminiowy
anodowany

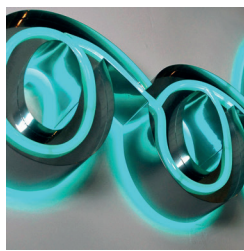

TAŚMY COB ST

IP
20

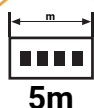

CE
RoHS

3LATA
GWARANCJI
3YEAR
WARRANTY

Nr. katalogowy/Catalog number	PA033669	PA033676	PA033683
Kod EAN/BARCODE	5908293933669	5908293933676	5908293933683
Ra (CRI)	>90	>90	>90
Ilość diod na m/LED per meter	480xCOB/m	480xCOB/m	480xCOB/m
Moc/Power	9W/m	9W/m	9W/m
Napięcie zasilające/Voltage	24V DC	24V DC	24V DC
Natężenie/Current	max 0,38A/m	max 0,38A/m	max 0,38A/m
Temperatura barwy/Colour temp.	3000K (+/-150K)	4000K (+/-250K)	6500K (+/-300K)
Strumień świetlny/Lumens	810lm/m	855lm/m	900lm/m
lm/W	90lm/W	95lm/W	100lm/W
Szerokość/Width	10 mm	10 mm	10 mm
Żywotność/Life Expectancy	30000h	30000h	30000h
Kąt świecenia/Lighting angle	120°	120°	120°

AKCESORIA dla COB 8mm

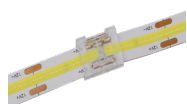

PG033607
Szybkozłącza
Taśma-Taśma



PG033614
Szybkozłącza
Taśma-Przewód 15cm



PG033621
Szybkozłącza
Taśma-Przewód 15 cm
-Taśma



PG033638
Szybkozłącza
Taśma-Taśma



PG033645
Szybkozłącza
Taśma-Przewód 15cm



PG033652
Szybkozłącza
Taśma-Przewód 15 cm
-Taśma

AKCESORIA dla COB 10mm



Poltronic S.A.
ul. Traugutta 1-7
50-449 Wrocław

+48 784 529 326
+48 784 529 350
+48 71 725 40 48 wew. 29
+48 71 725 40 48 wew. 30
biuro@poltronic.eu

